







FRENTE DE PLACARD

ALU
WIND

Aluminio Extruido



Tu Perfil

CÓDIGO	DESCRIPCIÓN	PESO Kg/M	FORMA	L. Std.	PÁGINA
G-11	Guia Inferior	0,195		6	1
G-14	Guia Superior	0,535		6	1
G-13	Parante de placard	0,392		6	1
G-12	Travesaño de hoja	0,232		6	2
L1515	Angulo 15x15	0,116		6	2
U1221	Perfil U 12x21	0,135		6	2

Tolerancia en peso +/- 10% L. Std: Largo Standard T x P. Tiras por paquete

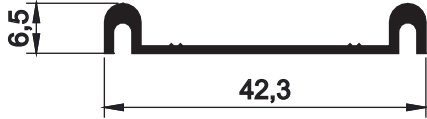

Código AW G-11 - Guia Inferior
0,195 Kg/m - Largo 6m

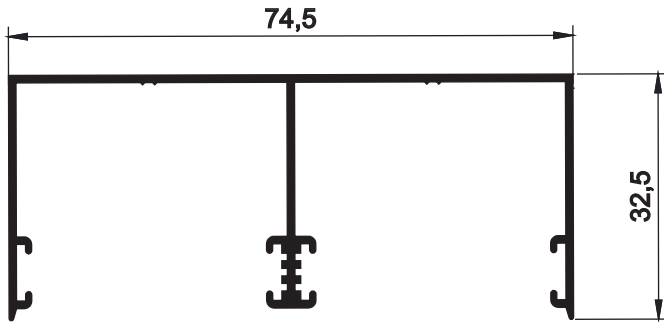
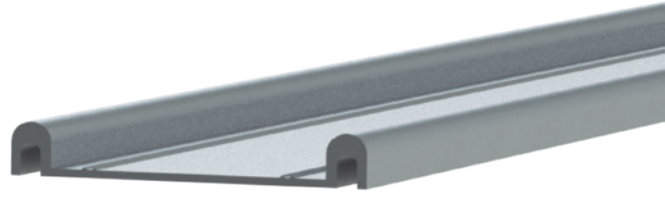

Código AW G-14 - Guia Superior
0,535 Kg/m - Largo 6m

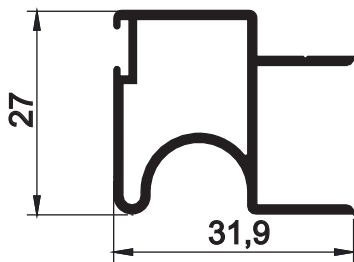
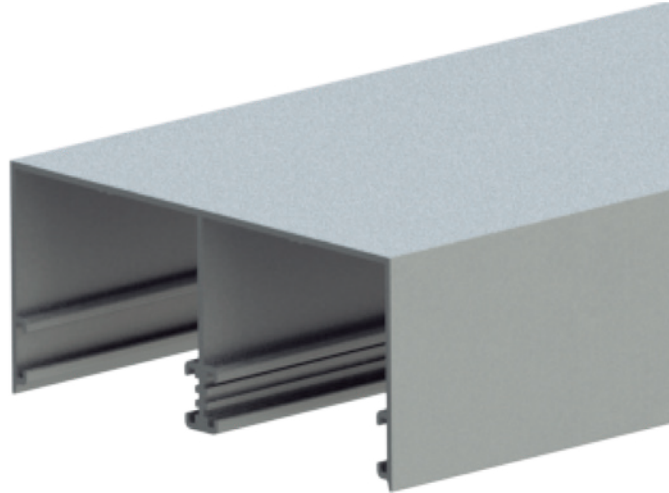

Código AW G-13 - Parante placard
0,392 Kg/m - Largo 6m

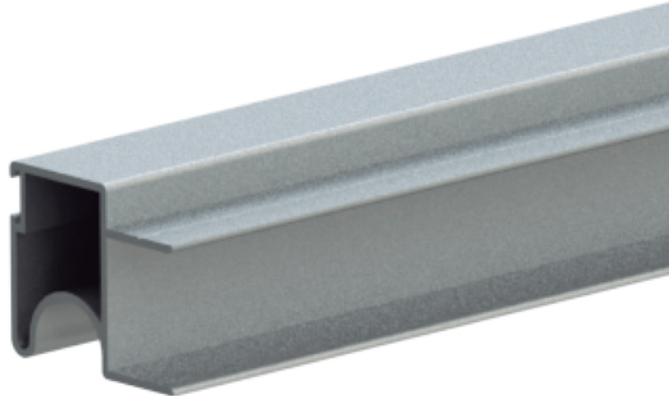

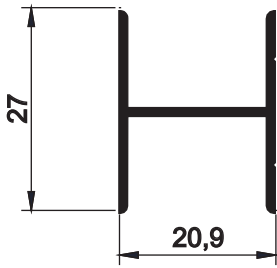

Código AW G-12 - Travesaño hoja
0,232 Kg/m - Largo 6m

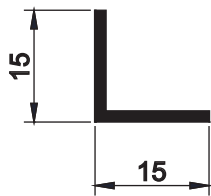
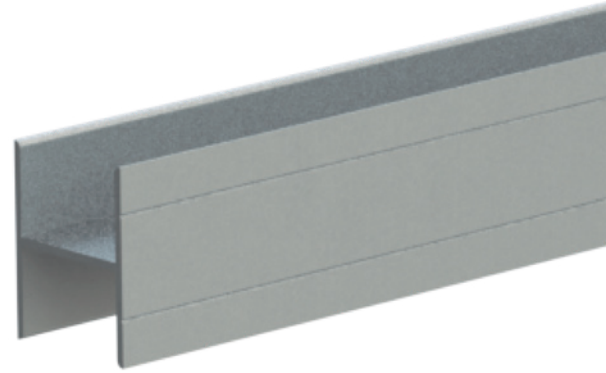

Código AW L1515 - Angulo 15*15
0,116 Kg/m - Largo 6m

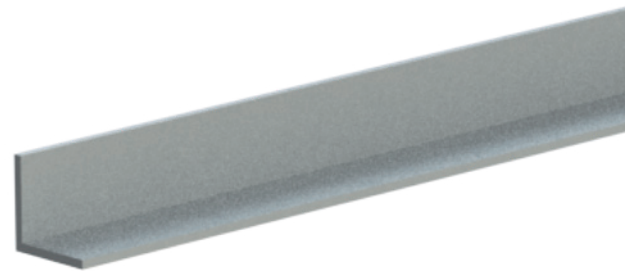

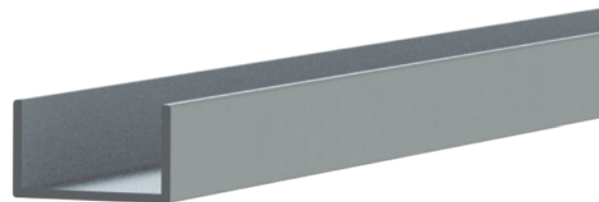

Código AW U1221 - Perfil U 12*21
0,135 Kg/m - Largo 6m



Medidas de corte placard de 2 hojas, corte a 90°

Perfil	Descripcion	Medida	Corte	Cantidad
AW G-11	Guia inferior de placard	A	90-90	1
AW G-14	Guia superior de placard	A	90-90	1
AW G-13	Parantes de placard	H-34	90-90	1
AW G-12	Travesaño de hoja	(A-98)/2	90-90	1-2

Listado de accesorios

Descripción	Cod	Marca	Imagen
Carro regulable de placard	TA-R17 N36C 157	TANIT MONPAT AXAL	
Felpa de 7 x 4.5mm	7X4,5	MONPAT	

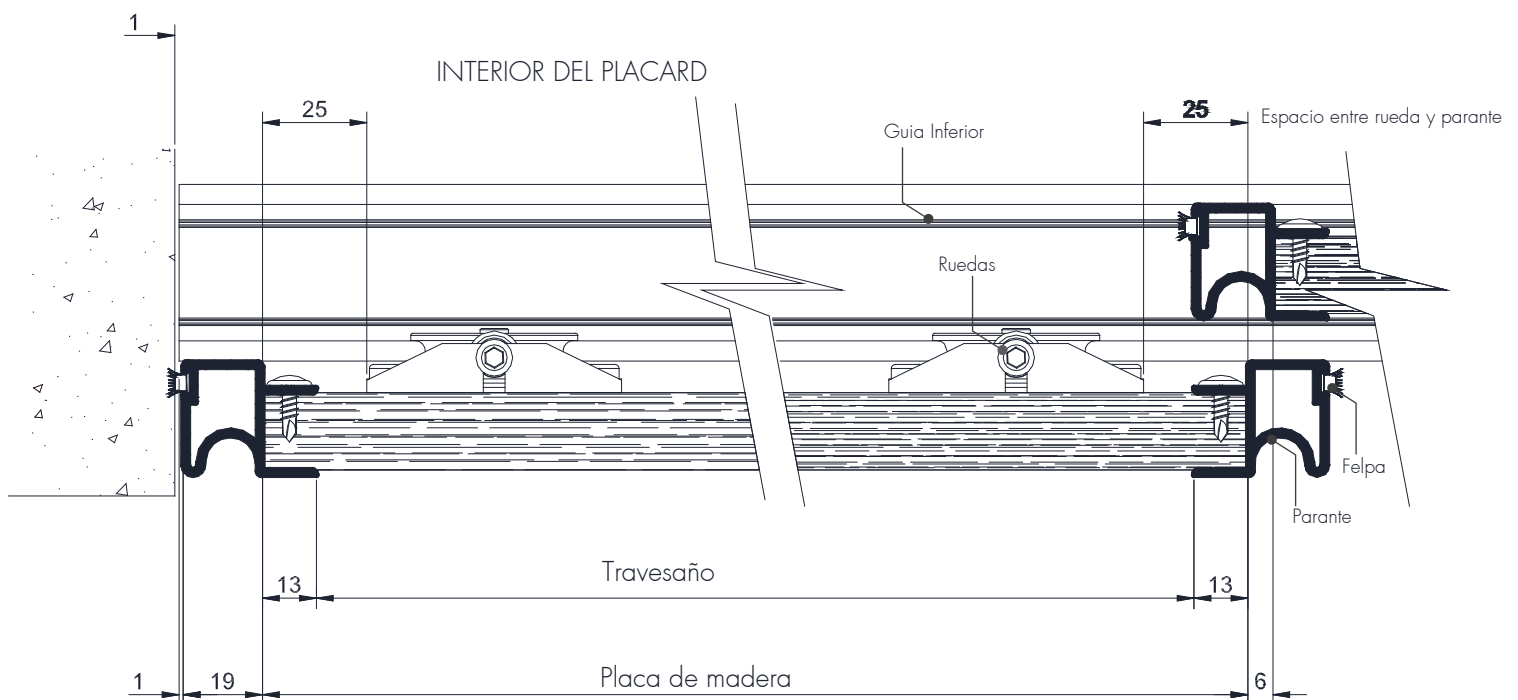

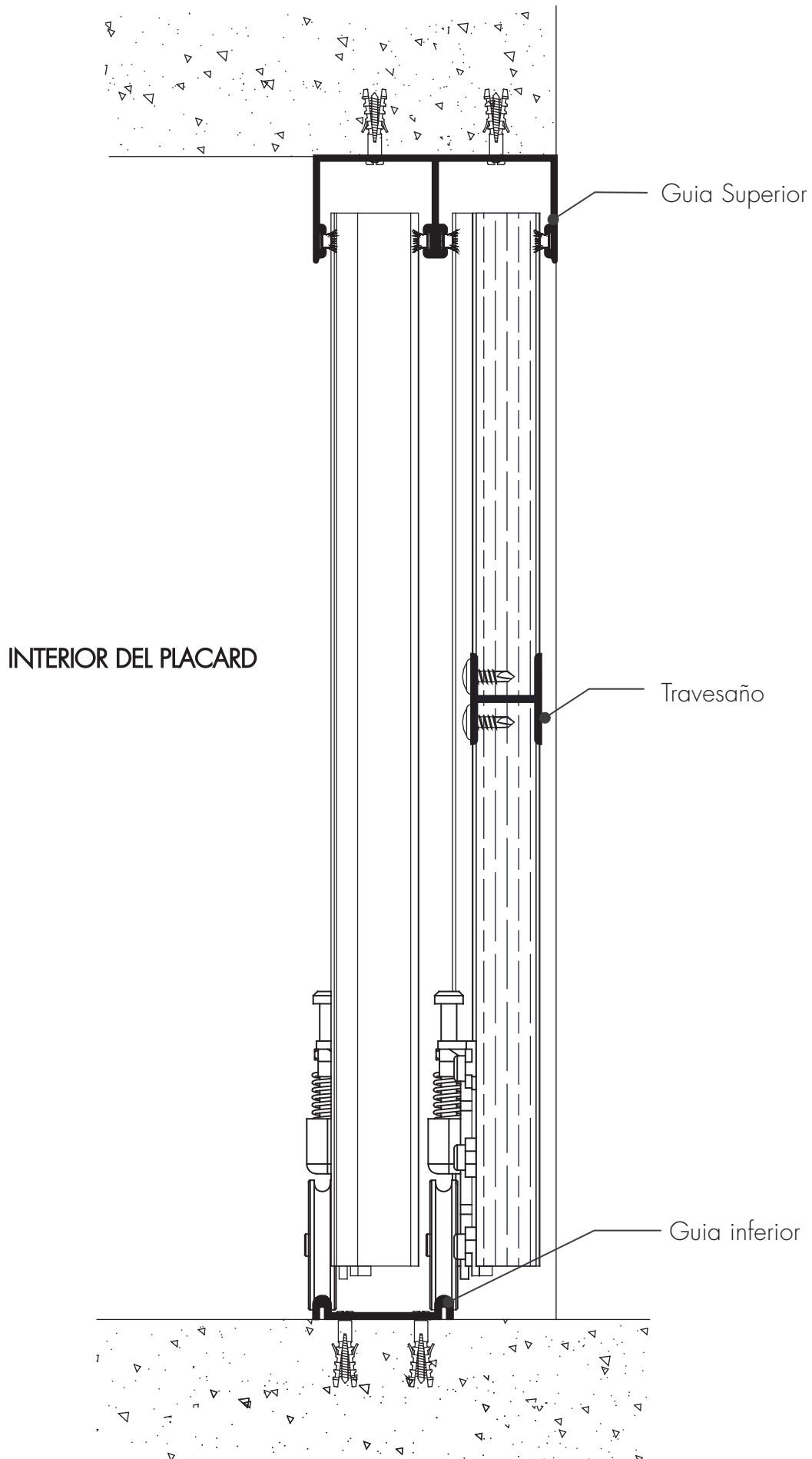

Despiece

N°	Código	Descripción
1	AW G-14	Guía superior
2	AW G-13	Parante
3	AW G-11	Guía inferior
4	AW G-12	Travesaño
5	AW L1515	Perfil L
6	-	Placa MDF
7	Tanit: TA R17 Monpat: N36C Axal: 157	Ruedas
8	7x4,5	Felpas
9	-	Tornillos

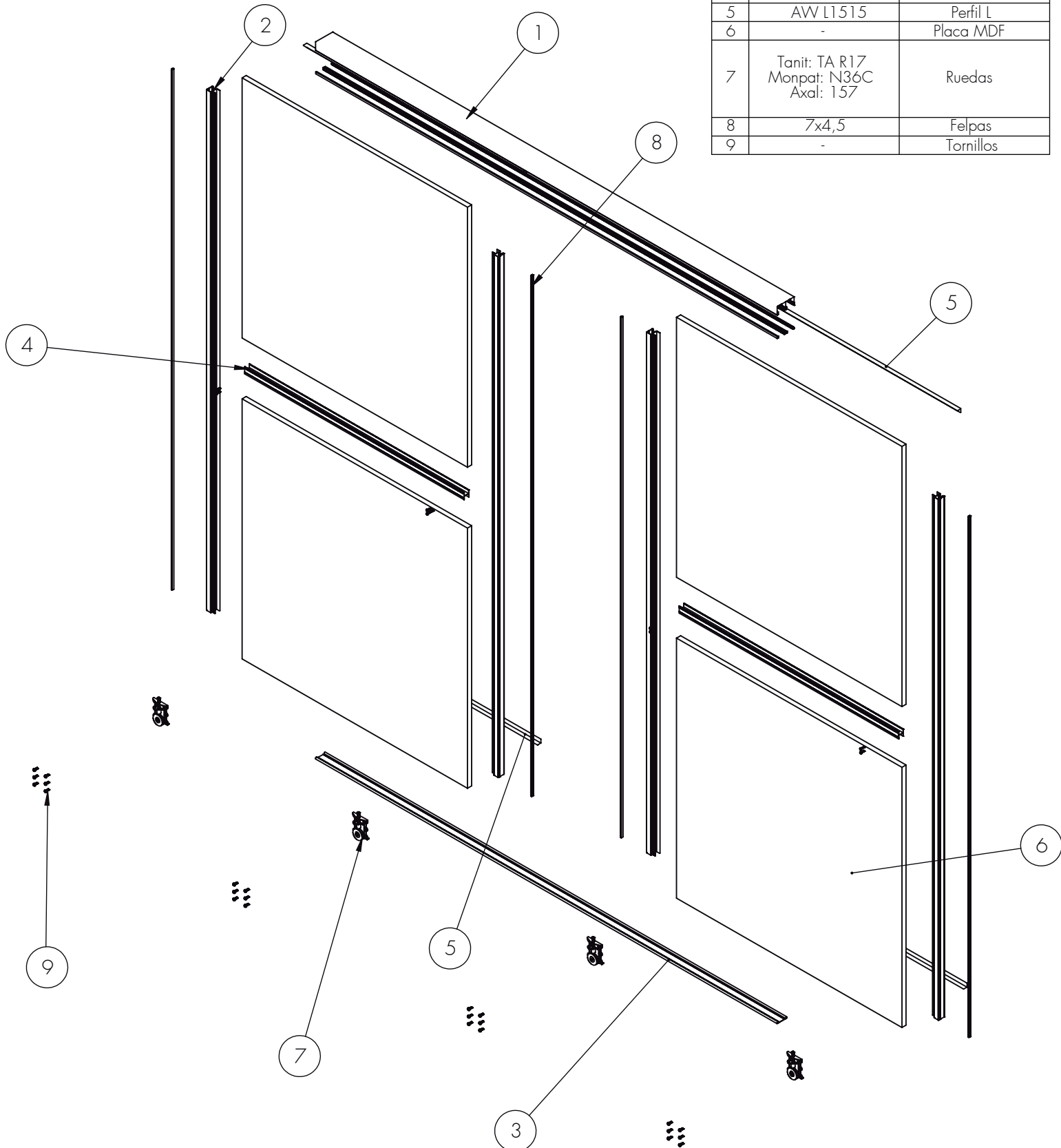

Posibilidades de armado

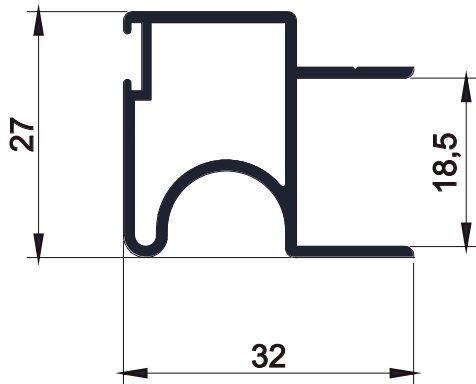

Perfil G-13
Parante-Tirador

Esesor admitido de placa de madera / vidrio

